



# Getting Started with Icepak: Transient Simulation



ANSYS, Inc.  
Southpointe  
2600 Ansys Drive  
Canonsburg, PA 15317  
[ansysinfo@ansys.com](mailto:ansysinfo@ansys.com)  
<https://www.ansys.com>  
(T) 724-746-3304  
(F) 724-514-9494

Release 2024 R2  
July 2024

ANSYS, Inc. and  
ANSYS Europe,  
Ltd. are UL  
registered ISO  
9001:2015 com-  
panies.

## Copyright and Trademark Information

© 1986-2024 ANSYS, Inc. Unauthorized use, distribution or duplication is prohibited.

ANSYS, Ansys Workbench, AUTODYN, CFX, FLUENT and any and all ANSYS, Inc. brand, product, service and feature names, logos and slogans are registered trademarks or trademarks of ANSYS, Inc. or its subsidiaries located in the United States or other countries. Icem CFD is a trademark used by ANSYS, Inc. under license. All other brand, product, service and feature names or trademarks are the property of their respective owners. FLEXIm and FLEXnet are trademarks of Flexera Software LLC.

## Disclaimer Notice

THIS ANSYS SOFTWARE PRODUCT AND PROGRAM DOCUMENTATION INCLUDE TRADE SECRETS AND ARE CONFIDENTIAL AND PROPRIETARY PRODUCTS OF ANSYS, INC., ITS SUBSIDIARIES, OR LICENSORS. The software products and documentation are furnished by ANSYS, Inc., its subsidiaries, or affiliates under a software license agreement that contains provisions concerning non-disclosure, copying, length and nature of use, compliance with exporting laws, warranties, disclaimers, limitations of liability, and remedies, and other provisions. The software products and documentation may be used, disclosed, transferred, or copied only in accordance with the terms and conditions of that software license agreement.

ANSYS, Inc. and ANSYS Europe, Ltd. are UL registered ISO 9001: 2015 companies.

## U.S. Government Rights

For U.S. Government users, except as specifically granted by the ANSYS, Inc. software license agreement, the use, duplication, or disclosure by the United States Government is subject to restrictions stated in the ANSYS, Inc. software license agreement and FAR 12.212 (for non-DOD licenses).

## Third-Party Software

See the legal information in the product help files for the complete Legal Notice for Ansys proprietary software and third-party software. If you are unable to access the Legal Notice, please contact ANSYS, Inc.

## Conventions Used in this Guide

Please take a moment to review how instructions and other useful information are presented in this documentation.

- Procedures are presented as numbered lists. A single bullet indicates that the procedure has only one step.
- Bold type is used for the following:
  - Keyboard entries that should be typed in their entirety exactly as shown. For example, “**copy file1**” means you must type the word **copy**, then type a space, and then type **file1**.
  - On-screen prompts and messages, names of options and text boxes, and menu commands. Menu commands are often separated by greater than signs (>). For example, “click **HFSS > Excitations > Assign > Wave Port.**”
  - Labeled keys on the computer keyboard. For example, “Press **Enter**” means to press the key labeled **Enter**.
- Italic type is used for the following:
  - Emphasis.
  - The titles of publications.
  - Keyboard entries when a name or a variable must be typed in place of the words in italics. For example, “**copy filename**” means you must type the word **copy**, then type a space, and then type the name of the file.
- The plus sign (+) is used between keyboard keys to indicate that you should press the keys at the same time. For example, “Press Shift+F1” means to press the **Shift** key and, while holding it down, press the **F1** key also. You should always depress the modifier key or keys first (for example, Shift, Ctrl, Alt, or Ctrl+Shift), continue to hold it/them down, and then press the last key in the instruction.

**Accessing Commands:** *Ribbons*, *menu bars*, and *shortcut menus* are three methods that can be used to see what commands are available in the application.

- The *Ribbon* occupies the rectangular area at the top of the application window and contains multiple tabs. Each tab has relevant commands that are organized, grouped, and labeled. An example of a typical user interaction is as follows:

"Click **Draw > Line**"

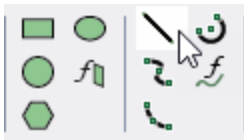

This instruction means that you should click the **Line** command on the **Draw** ribbon tab. An image of the command icon, or a partial view of the ribbon, is often included with the instruction.

- The *menu bar* (located above the ribbon) is a group of the main commands of an application arranged by category such File, Edit, View, Project, etc. An example of a typical user interaction is as follows:

"On the **File** menu, click the **Open Examples** command" means you can click the **File** menu and then click **Open Examples** to launch the dialog box.

- Another alternative is to use the *shortcut menu* that appears when you click the right-mouse button. An example of a typical user interaction is as follows:

"Right-click and select **Assign Excitation> Wave Port**" means when you click the right-mouse button with an object face selected, you can execute the excitation commands from the shortcut menu (and the corresponding sub-menus).

### Getting Help: Ansys Technical Support

For information about Ansys Technical Support, go to the Ansys corporate Support website, <http://www.ansys.com/Support>. You can also contact your Ansys account manager in order to obtain this information.

All Ansys software files are ASCII text and can be sent conveniently by e-mail. When reporting difficulties, it is extremely helpful to include very specific information about what steps were taken or what stages the simulation reached, including software files as applicable. This allows more rapid and effective debugging.

### Help Menu

To access help from the Help menu, click **Help** and select from the menu:

- **[product name] Help** - opens the contents of the help. This help includes the help for the product and its *Getting Started Guides*.
- **[product name] Scripting Help** - opens the contents of the *Scripting Guide*.
- **[product name] Getting Started Guides** - opens a topic that contains links to Getting Started Guides in the help system.

### Context-Sensitive Help

To access help from the user interface, press **F1**. The help specific to the active product (design type) opens.

You can press **F1** while the cursor is pointing at a menu command or while a particular dialog box or dialog box tab is open. In this case, the help page associated with the command or open dialog box is displayed automatically.

---

# Table of Contents

---

<b>Table of Contents</b> .....	<b>Contents-1</b>
<b>1 - Introduction</b> .....	<b>1-1</b>
<b>2 - Set Up the Project</b> .....	<b>2-1</b>
Launch the Ansys Electronics Desktop .....	2-1
Set 3D UI Options .....	2-1
Open the Project .....	2-2
Set Solution Type .....	2-3
<b>3 - Define Transient Simulation Settings</b> .....	<b>3-1</b>
Review the Piecewise Linear Dataset .....	3-1
Assign the Piecewise Linear Dataset .....	3-2
Review the Transient Fan Option .....	3-3
<b>4 - Review the Solve Setup and Run the Analysis</b> .....	<b>4-1</b>
Review the Solve Setup .....	4-1
Run the Analysis and Monitor the Results .....	4-4
<b>5 - Post-process the Solution</b> .....	<b>5-1</b>
Create a Fields Summary .....	5-1
Create a Temperature Plot .....	5-3
Modify the Temperature Plot Range .....	5-5
Animate the Temperature Plot .....	5-6



# 1 - Introduction

This document is intended as supplementary material to Icepak for beginners and advanced users. It includes instructions to define transient settings, solve, and analyze a simple heat pipe model.

This chapter contains the following topic:

- Sample Project - The Heat Pipe

## Sample Project - The Heat Pipe

In this project, you will learn how to define a dataset and assign transient settings. Icepak solves conservation equations of mass, momentum, and energy to provide flow and thermal fields.

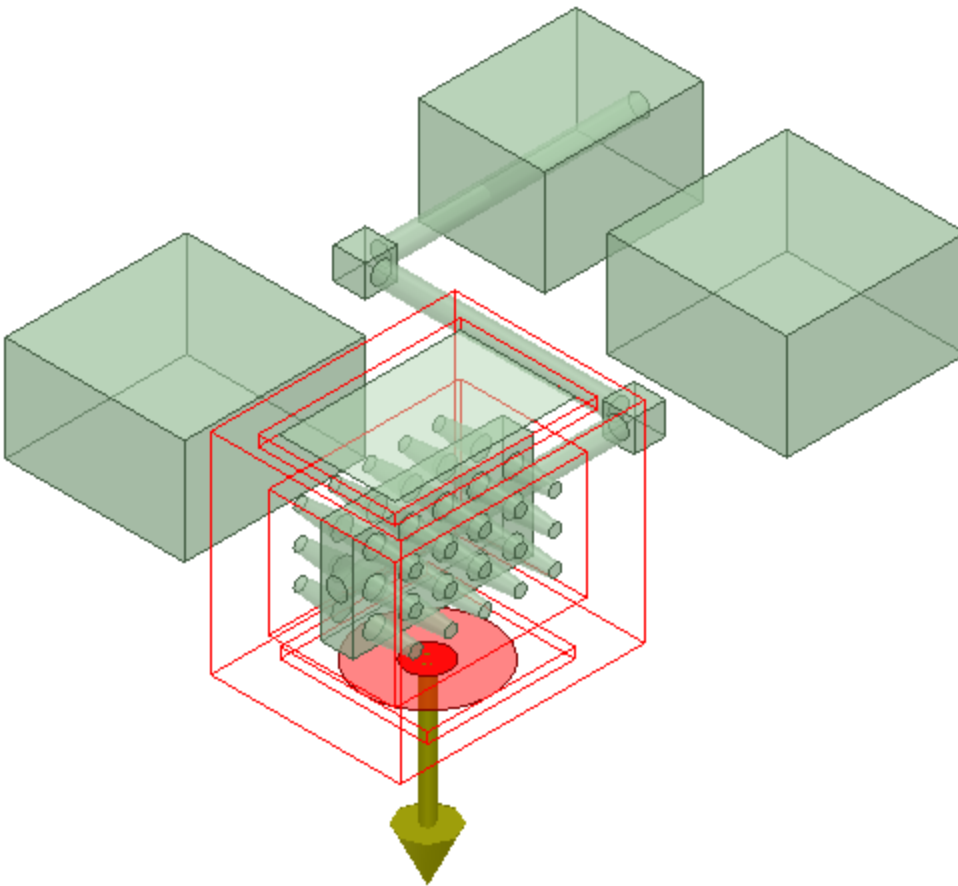

Figure 1-1: Heat Pipe





## 2 - Set Up the Project

This chapter contains the following topics:

- "Launch the Ansys Electronics Desktop" below
- [Set the Solution Type](#)

### Launch the Ansys Electronics Desktop

A shortcut of the Ansys Electronics Desktop application appears on your desktop once the application is installed.

### Set 3D UI Options

Ensure that the new view orientation scheme introduced in release 2024 R1 is not being used, since the instructions and images in this guide are based on the legacy orientation scheme.

1. From the menu bar, click **View > Options**.

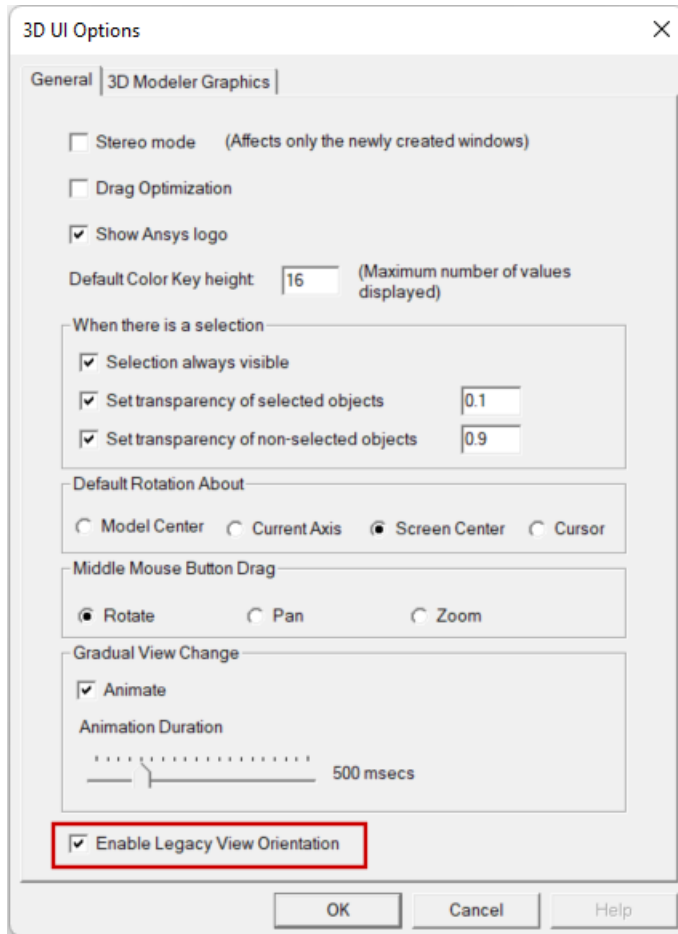

The *3D UI Options* dialog box appears.

2. Ensure that **Enable Legacy View Orientation** is enabled:



3. Click **OK**.

## Open the Project

1. On the **Desktop** ribbon tab, click  **Open Examples**. Then:
  - a. In the *Open* dialog box that appears, click the parent folder icon () once to move up one level above the *Examples* folder.
  - b. Double-click the **Help** folder and then the **Icepak** folder.
  - c. Select the file **Heat\_Pipe\_Geometry.aedt** and click **Open**.
2. The model is displayed in the **3D Modeler** window.

**Note:** You can hide the grid by selecting **View > Grid Settings** and then selecting **Hide** in the **Grid Spacing** dialog box. Also, from the **View > Coordinate Systems** menu, you can hide the large coordinate triad and display a smaller coordinate triad in the bottom of the **3D Modeler** window.

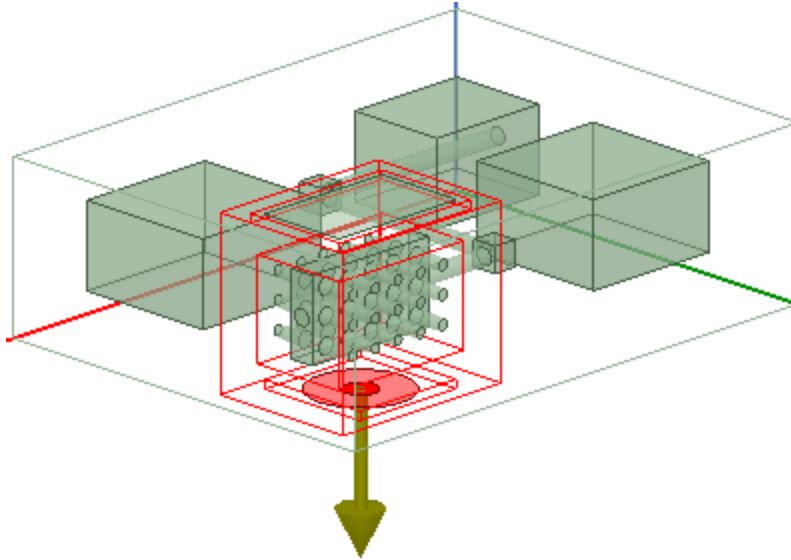

**Figure 2-1: Heat Pipe model in the 3D Modeller window**

3. From the **File** menu, select **Save As**, and save the project in the desired working directory.

## Set Solution Type

Specify the design's solution type as follows:

1. Click **Icepak >Solution Type**.  
The **Solution Type** dialog box appears.
2. Under **Solution types**, select **Transient**.
3. Under **Problem types**, ensure **Temperature and Flow** is selected and click **OK**.

### **Note:**

To automatically set **Transient** as the default solution type for new designs, select **Save as default**

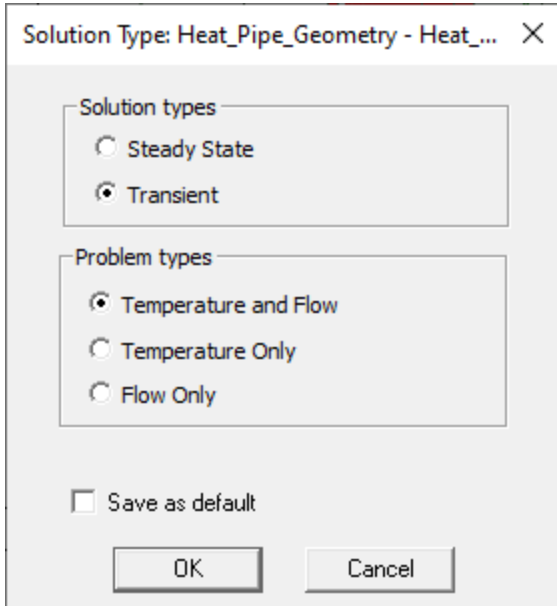

**Figure 2-2: Solution Type**

## 3 - Define Transient Simulation Settings

Certain boundary condition and native 3D component parameters can be defined as transient. In this simulation, the block power is transient. We'll also examine the fan component's **Transient Strength** option.

**Note:**

Refer to **Transient Thermal Properties Dependency** in the main Icepak help for a list of which boundary condition and native 3D component parameters can be defined as transient.

This chapter contains the following topics:

- [Review the Piecewise Linear Dataset](#)
- [Assign the Piecewise Linear Dataset](#)
- [Review the Transient Fan Option](#)

### Review the Piecewise Linear Dataset

This transient simulation uses a piecewise linear variation function to define time-dependent power in the block object. Perform the following steps to review the dataset that specifies the piecewise linear power.

1. From the **Icepak** menu, select **Design Datasets**.
2. In the **Datasets** dialog box, select the **ds\_pwr** dataset and click **Edit**.

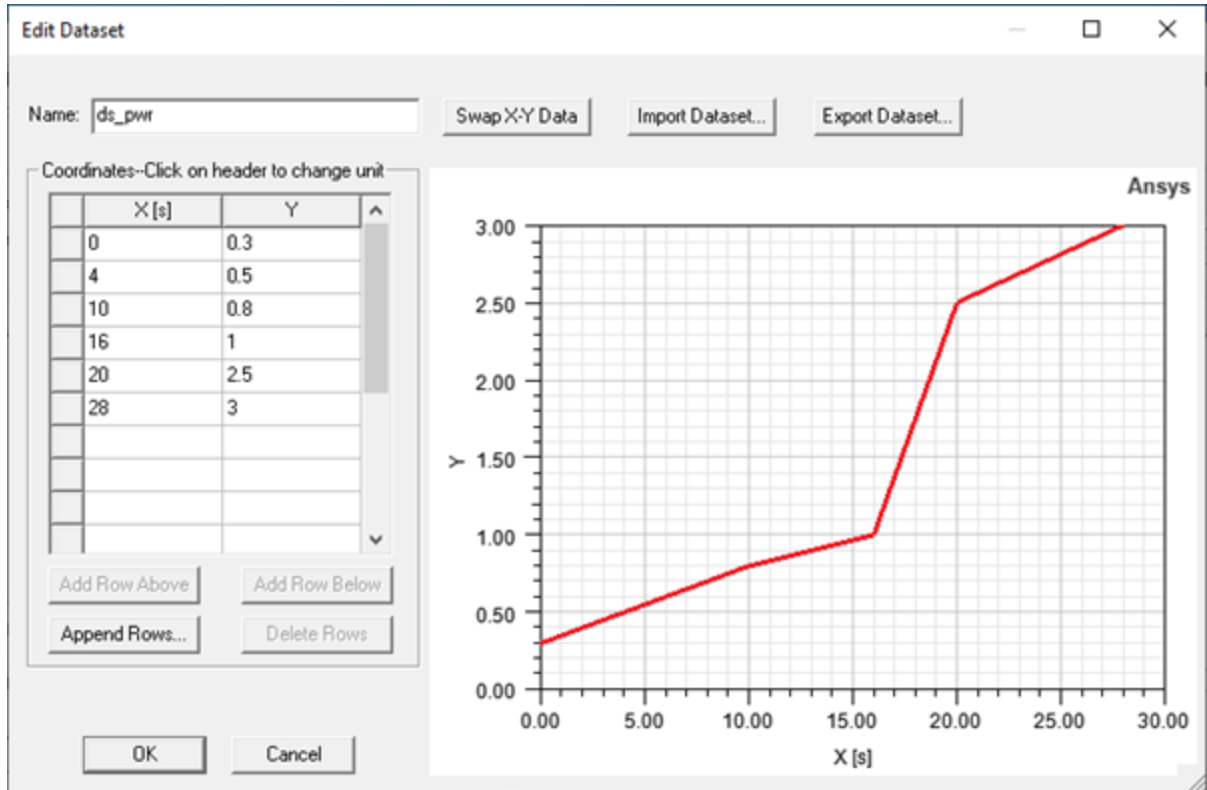

- Note the X and Y column values. The X column is specified in seconds, and the Y axis specifies the multiplier to be applied to the assigned boundary condition's total power value. In this project, the dataset is assigned to the *block\_1* boundary condition. In the next section, you will assign transient power to the block and review the total power values at the specified time intervals.
- Click **Cancel** to close the **Edit Dataset** dialog box.
- Click **Done** to close the **Datasets** dialog box.

## Assign the Piecewise Linear Dataset

Assign transient power to the block boundary condition using the existing dataset.

- In the **Project Manager**, expand **Thermal** to view the assigned Icepak boundary conditions.
- Double-click **block\_1**.
- For **Total Power**, enable the check box and select **Transient** from the drop-down list.
- Click **Edit** to open the **Total Power - Transient Variation** dialog box.
- For **Variation function**, select **Piecewise Linear**.
- For **S0**, enter **25 W**.
- For **Variation**, select **ds\_pwr**.

- Click **Apply** to assign the piecewise linear dataset to the variation function. The graph is updated with the curve.

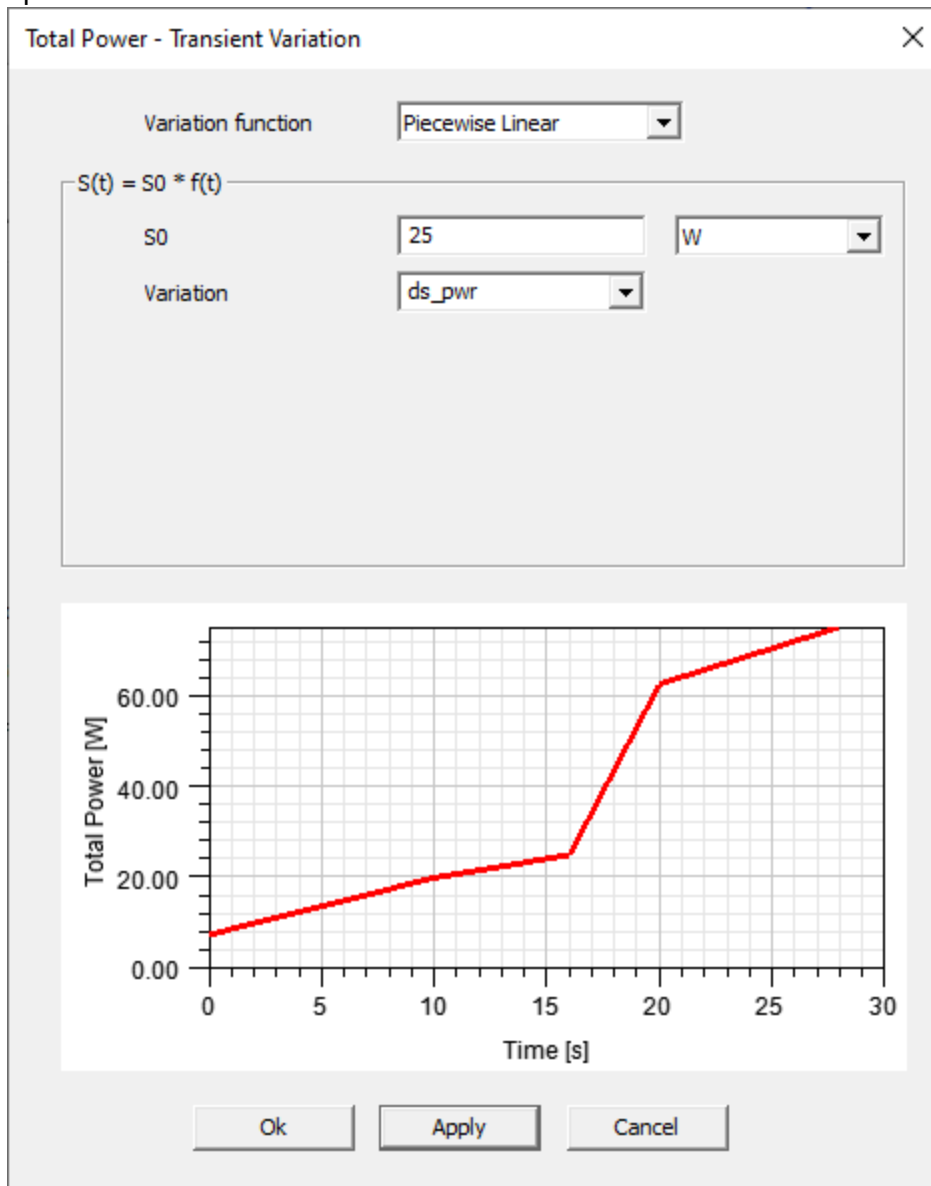

- Click **Ok** to close the **Total Power -Transient Variation** dialog box.
- Click **OK** to close the **Block Thermal Model** dialog box.

## Review the Transient Fan Option

This model also includes a fan native 3D component. Open the fan properties to review its transient option, **Transient Strength**.

- In the **Project Manager**, expand **3D Components**.
- Right-click **fan\_1\_1** and select **Edit Definition**.

3. On the **Property** tab, click the check box next to **Transient Strength**.
4. Review the **Transient Strength - Transient Variation** dialog box. Note the Variation function options.

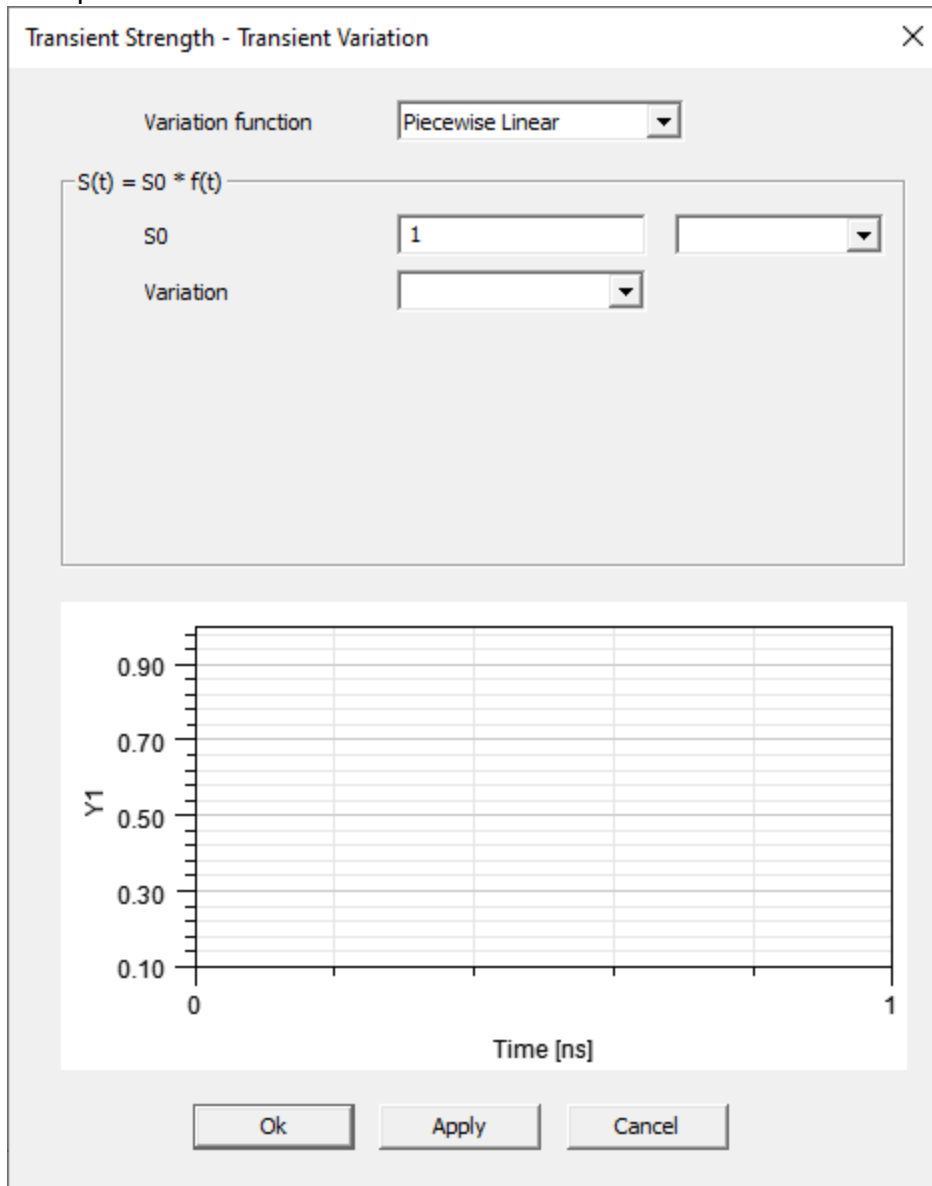

5. This simulation does not include **Transient Strength**, so click **Cancel** to close the **Transient Strength - Transient Variation** dialog box.
6. Click **Cancel** to close the **Fan Component** dialog box.



# 4 - Review the Solve Setup and Run the Analysis

Before running the analysis, review the available transient options in the solve setup.

This chapter contains the following topics:

- [Review the Solve Setup](#)
- [Run the Analysis and Monitor the Results](#)

## Review the Solve Setup

1. In the **Project Manager**, expand **Analysis**.
2. Double-click **Setup1** to open the **Icepak Solve Setup Dialog**.
3. On the **General** tab, enter the settings under **Transient Setup**. The duration of the simulation is 30 seconds with a time step occurring every 2 second, and 150 iterations will occur for each time step.

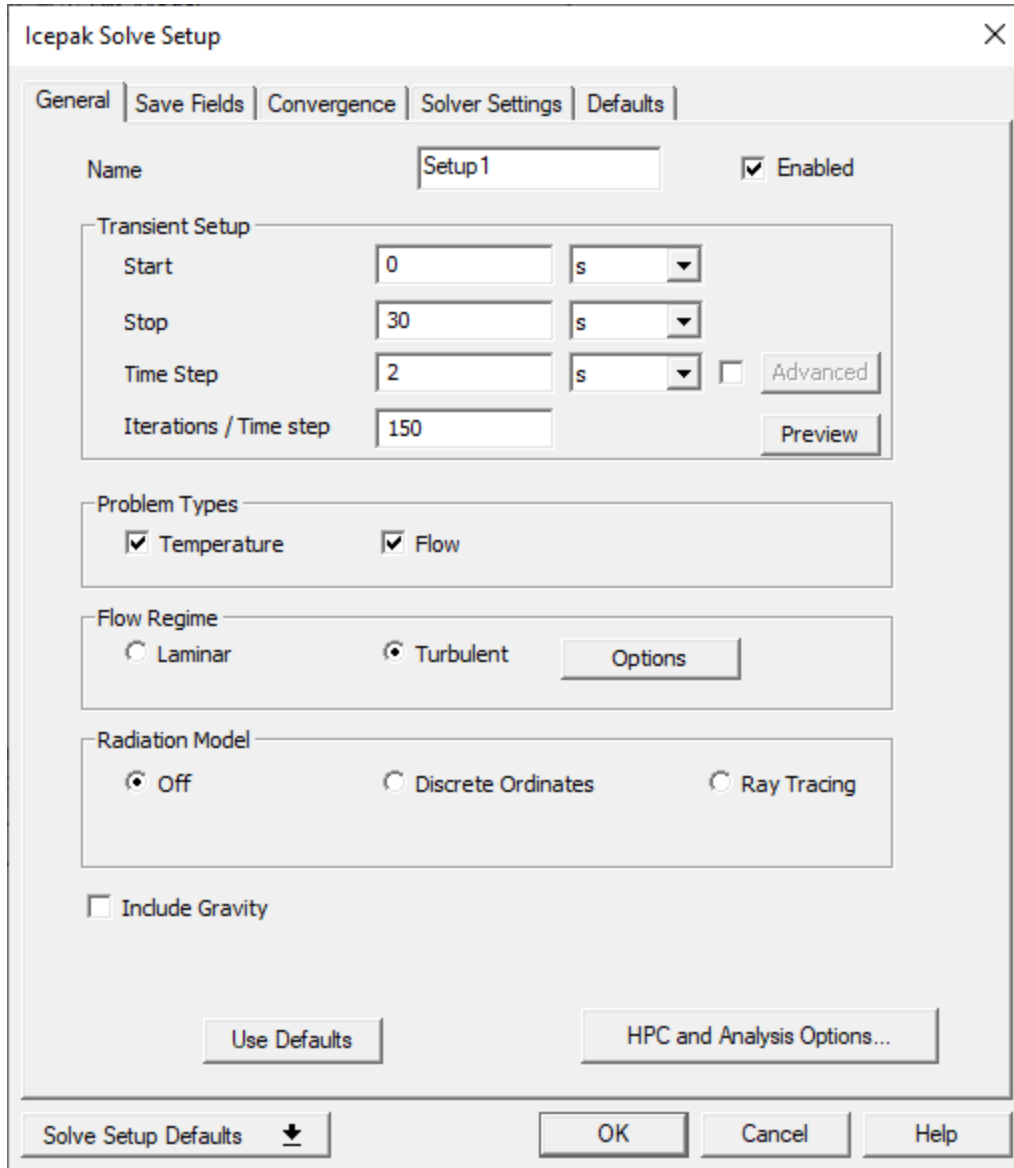

4. Click **Preview** to display the **Variations Preview** dialog box, which shows all parameters defined as transient for the analysis. The block object's transient power is displayed. Close the dialog box.

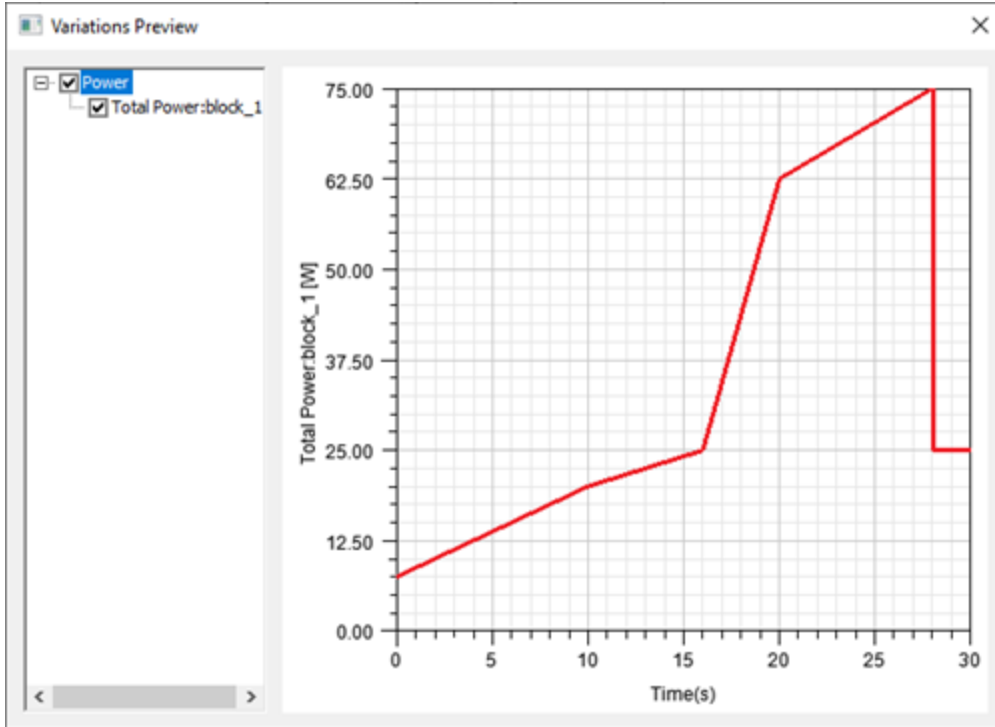

5. On the **Save Fields** tab, enter 1 to ensure that fields for post-processing will be saved every time step. Note the **Varying** option, which allows you to save fields data at varying intervals using a transient variation function.

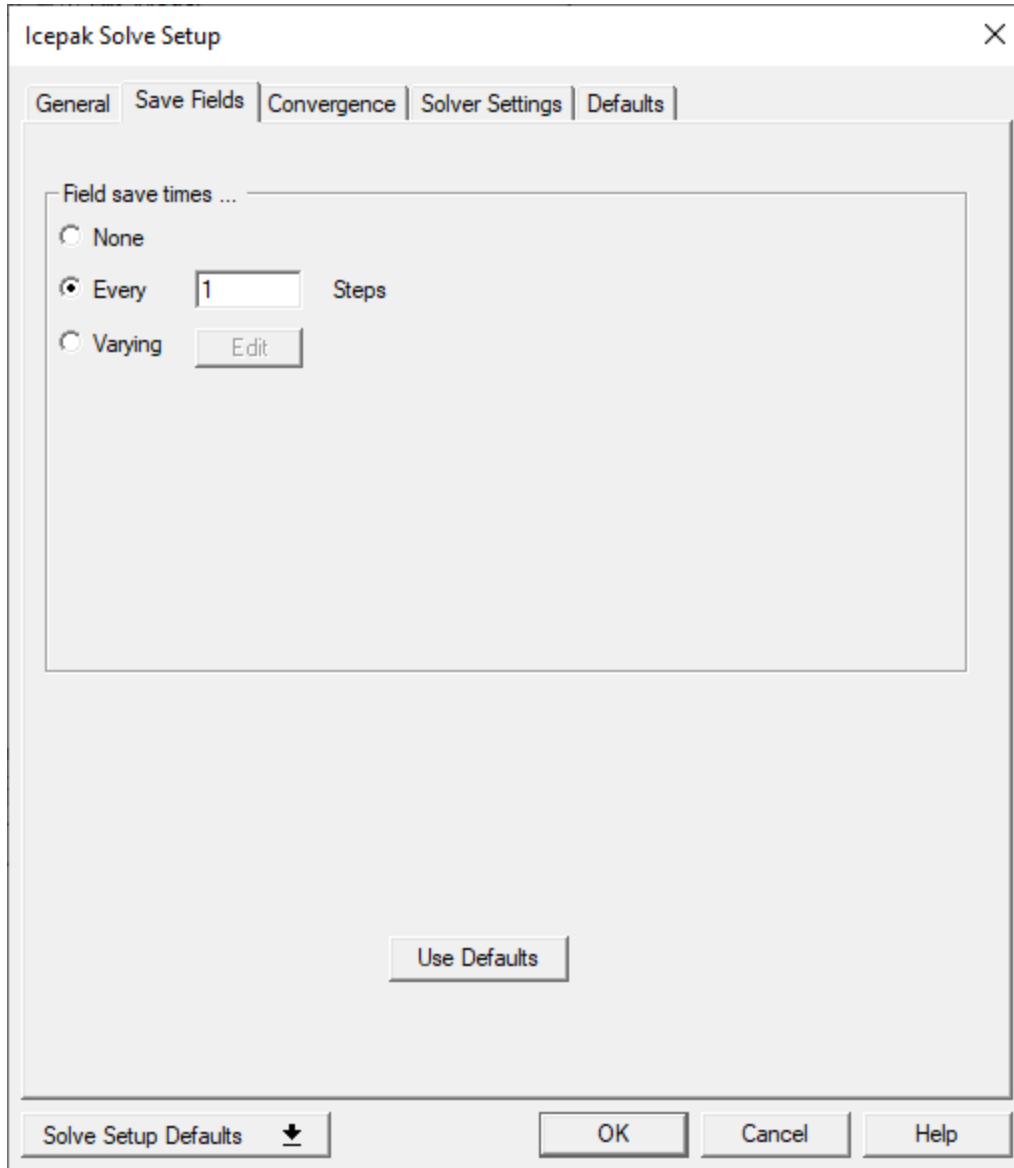

6. Click **OK** to close the **Icepak Solve Setup Dialog**.

## Run the Analysis and Monitor the Results

1. In the **Project Manager**, right-click **Analysis** and select **Analyze**.
2. Right-click **Setup1** and select **Thermal Monitor** to open the **Solutions** dialog box.
3. Note the X axis on the monitor graph is **Time(s)**. The graph displays the monitor temperature data at each time step.

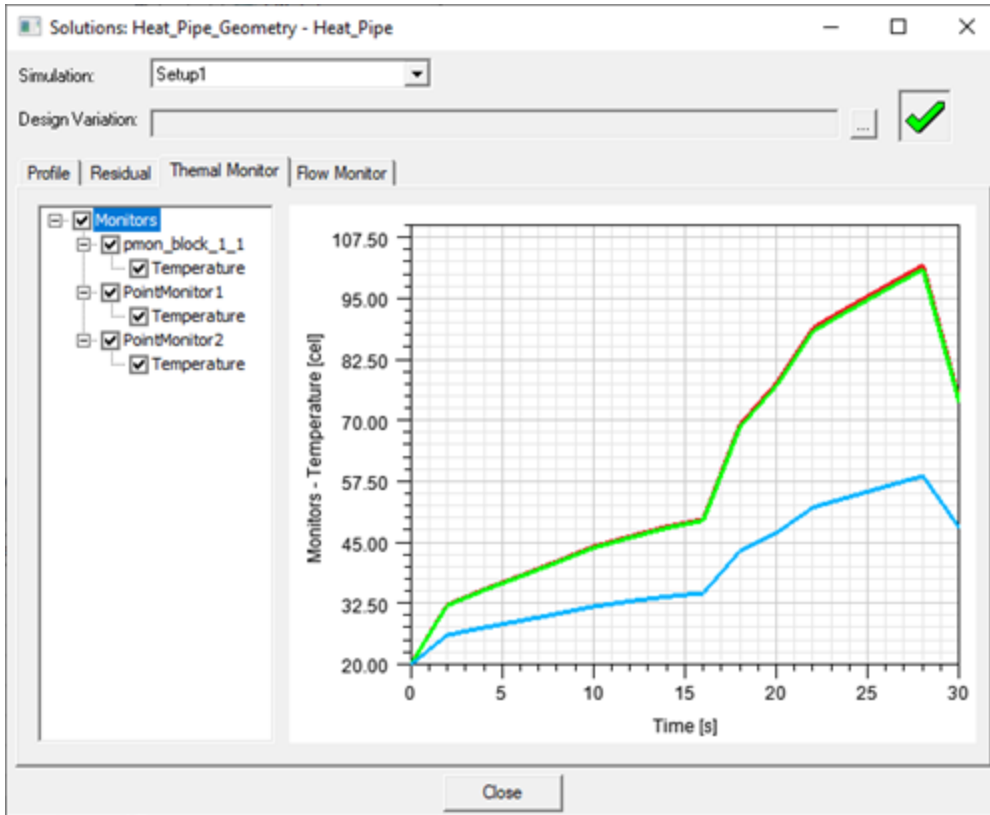

4. Click the **Flow Monitor** tab to review the monitor flow data at each time step.

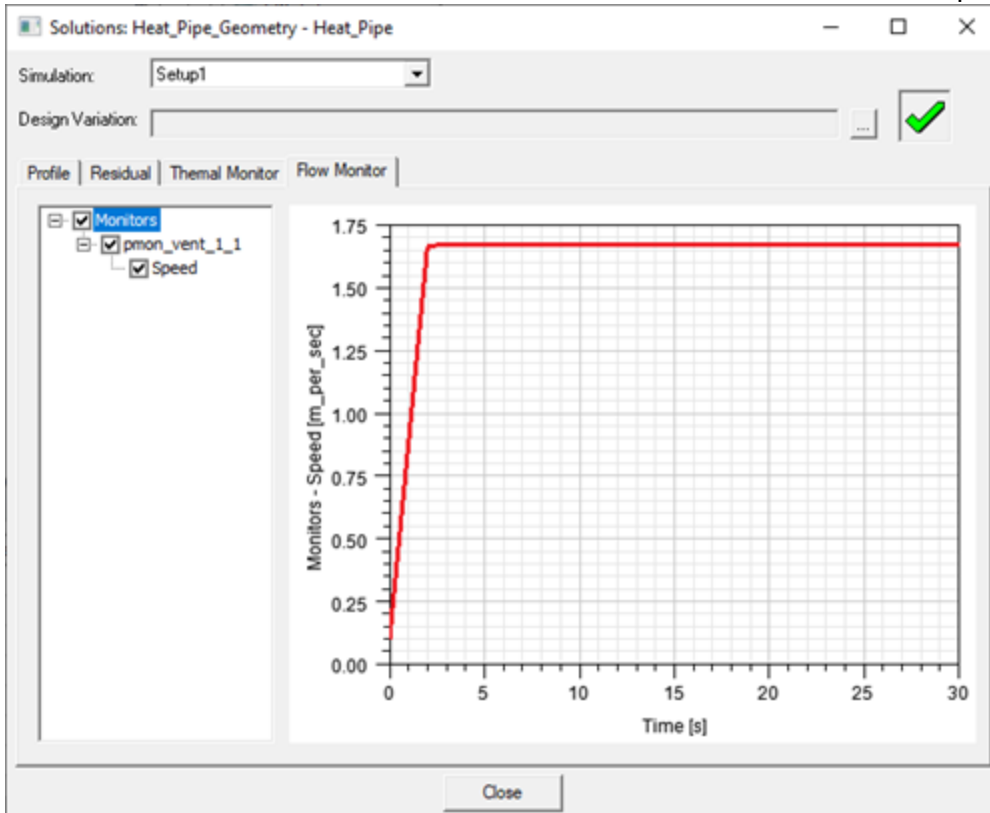

5. Click **Close**.

## 5 - Post-process the Solution

After the analysis is complete, post-process the results to review temperature data at the various time steps.

This chapter contains the following topics:

- [Create a Fields Summary](#)
- [Create a Temperature Plot](#)
- [Animate the Temperature Plot](#)

### Create a Fields Summary

Create a fields summary report to display the temperature of the block at each time step.

1. In the **Project Manager**, right-click **Field Overlays**.
2. Select **Create Fields Summary**.
3. In the **Fields Summary** dialog box, select **All times** in the **Time** drop-down list.
4. In the **Setup Calculation** dialog box, retain the selections for **Entity Type**, **Geometry Type**, and **Side**.
5. Under **Entity**, select **block\_1**.
6. Under **Quantity**, select **Temperature**.

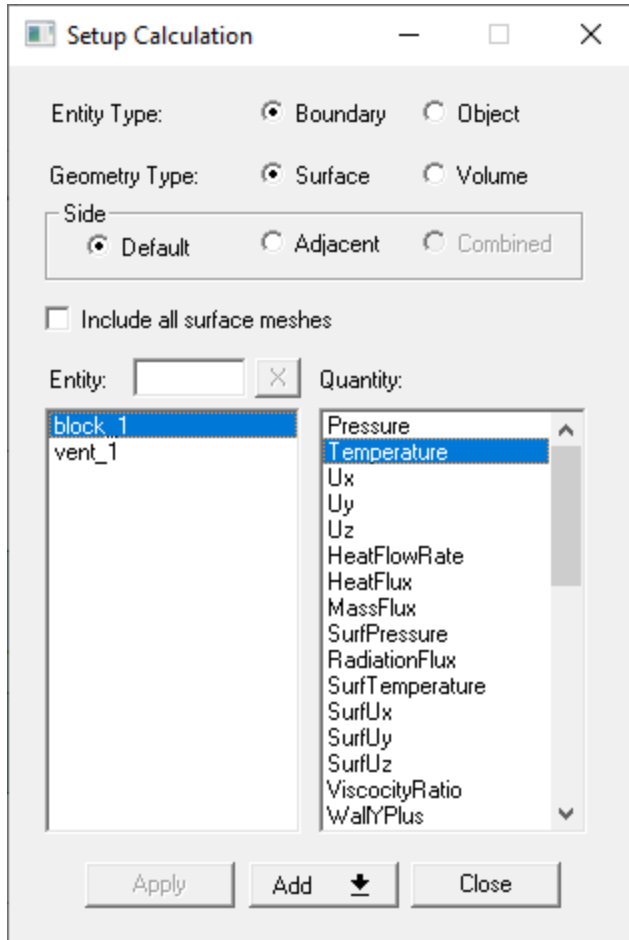

7. From the **Add** drop-down list, select **Add as a Single Calculation**.
8. In the **Fields Summary** dialog box, review the temperature of the block at each time step.



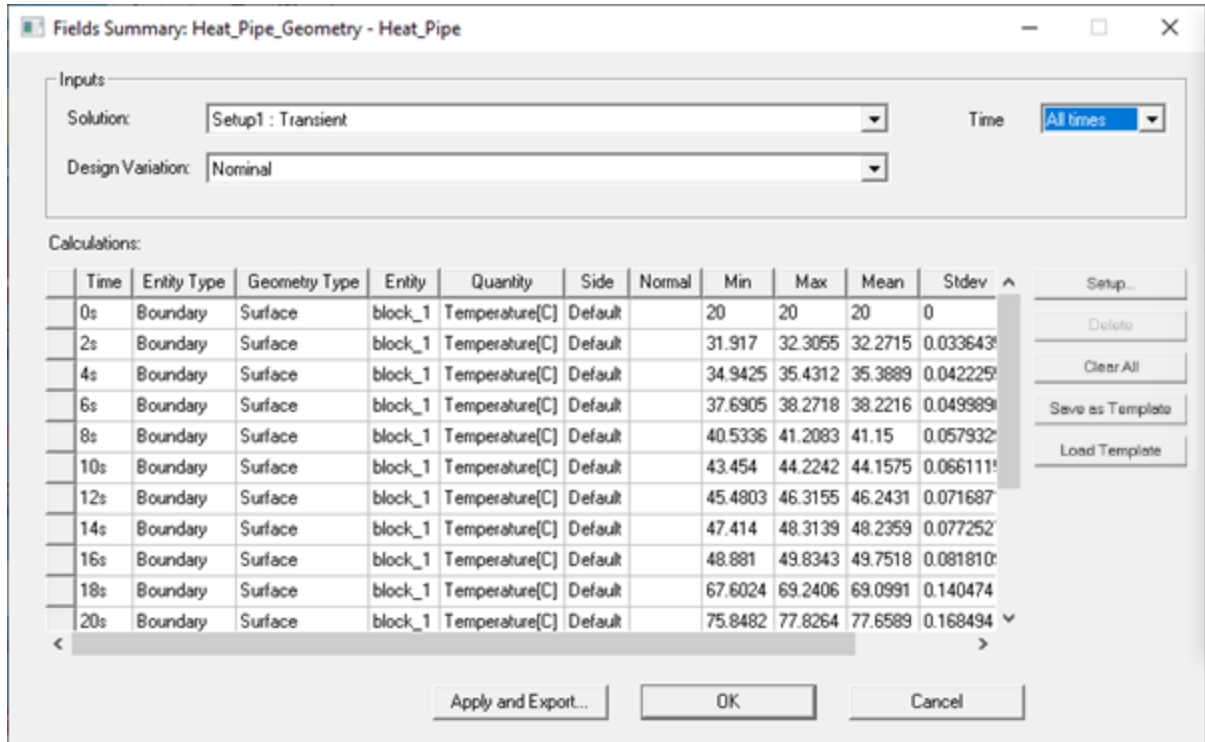

9. Click **OK**.

## Create a Temperature Plot

1. In the history tree, expand **Solids**.
2. Expand **material\_1**, **material\_3**, and **material\_4**.
3. Press the **Shift** key and select all geometry under **material\_1**, **material\_3**, and **material\_4**.
4. Right-click in the **3D Modeler** window.
5. Select **Plot Fields > Temperature > SurfTemperature**.
6. Under **Intrinsic Variables**, select a **Time** of **24s**.
7. Select **Plot on surface only**.

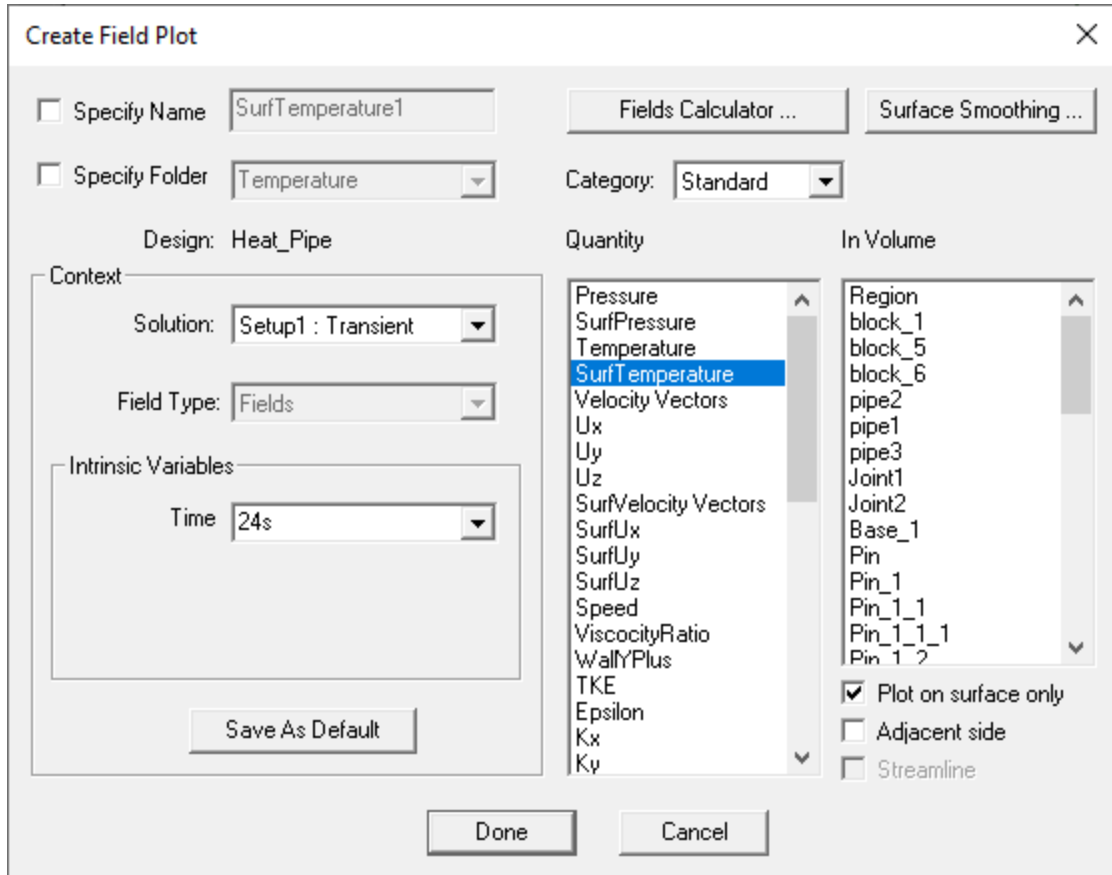

8. Click **Done**.

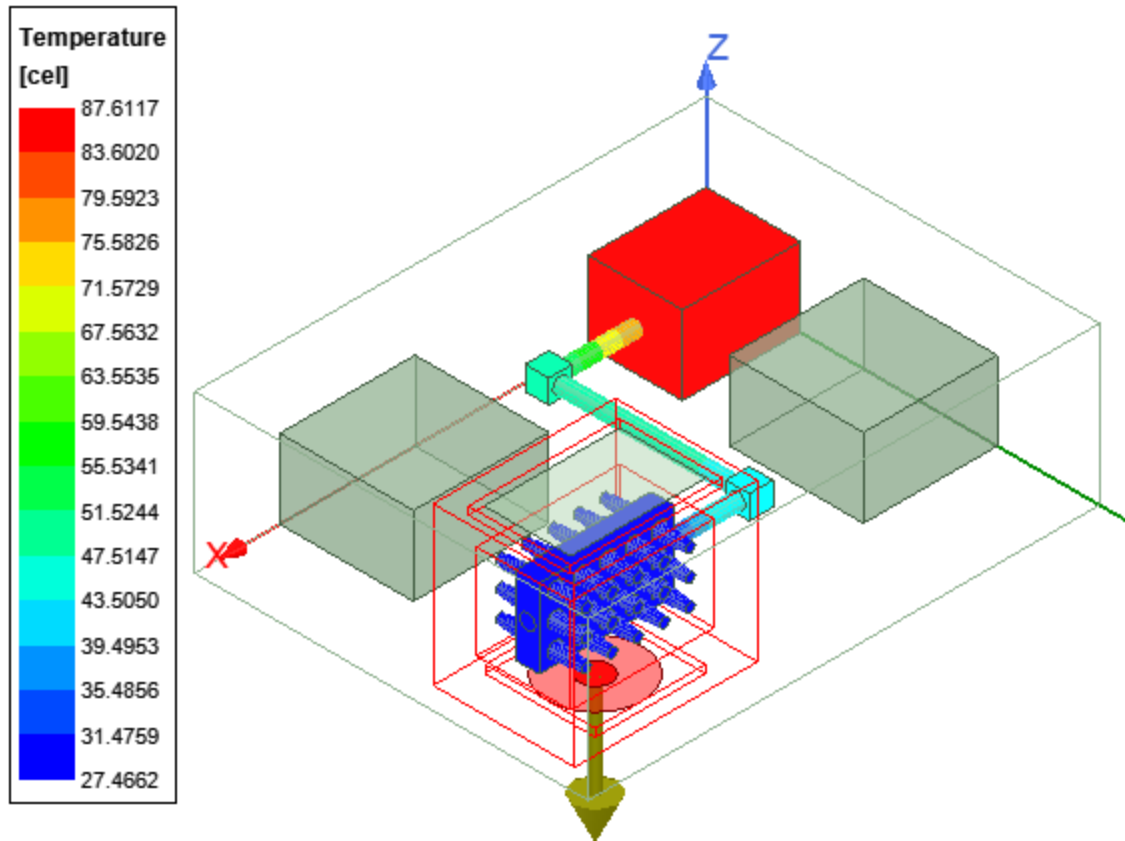

## Modify the Temperature Plot Range

To enhance the visualization of animating the temperature plot, first modify the range of temperatures displayed.

1. In the **3D Modeler** window, right-click on the **Temperature** legend and select **Modify**.
2. In the **Heat Pipe -- Temperature** dialog box, click the **Scale** tab.
3. Select **Use Limits** and enter the following values:
  - **Min:** 22
  - **Max:** 35

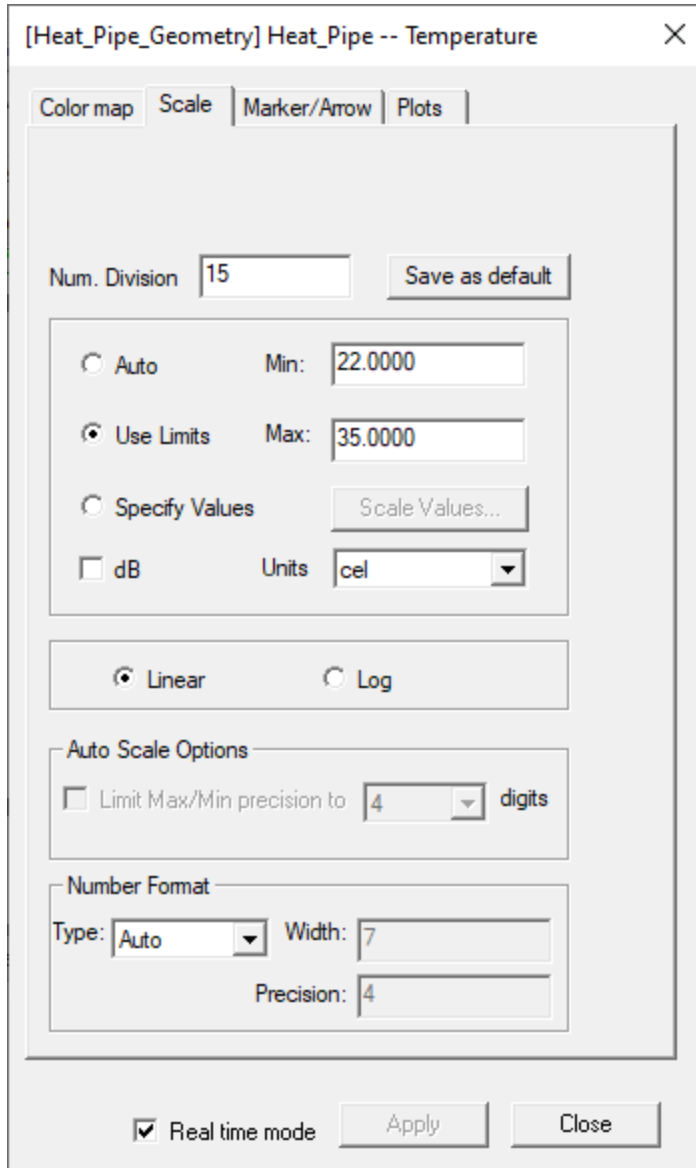

4. Click **Apply** and then **Close**.

## Animate the Temperature Plot

1. In the **Project Manager**, expand **Field Overlays > Temperature**.
2. Right-click **SurfTemperature1** and select **Animate**.
3. In the **Select Animation** dialog box, click **OK**.
4. In the **Animation** dialog box, adjust the **Speed** slider bar to slow the animation.

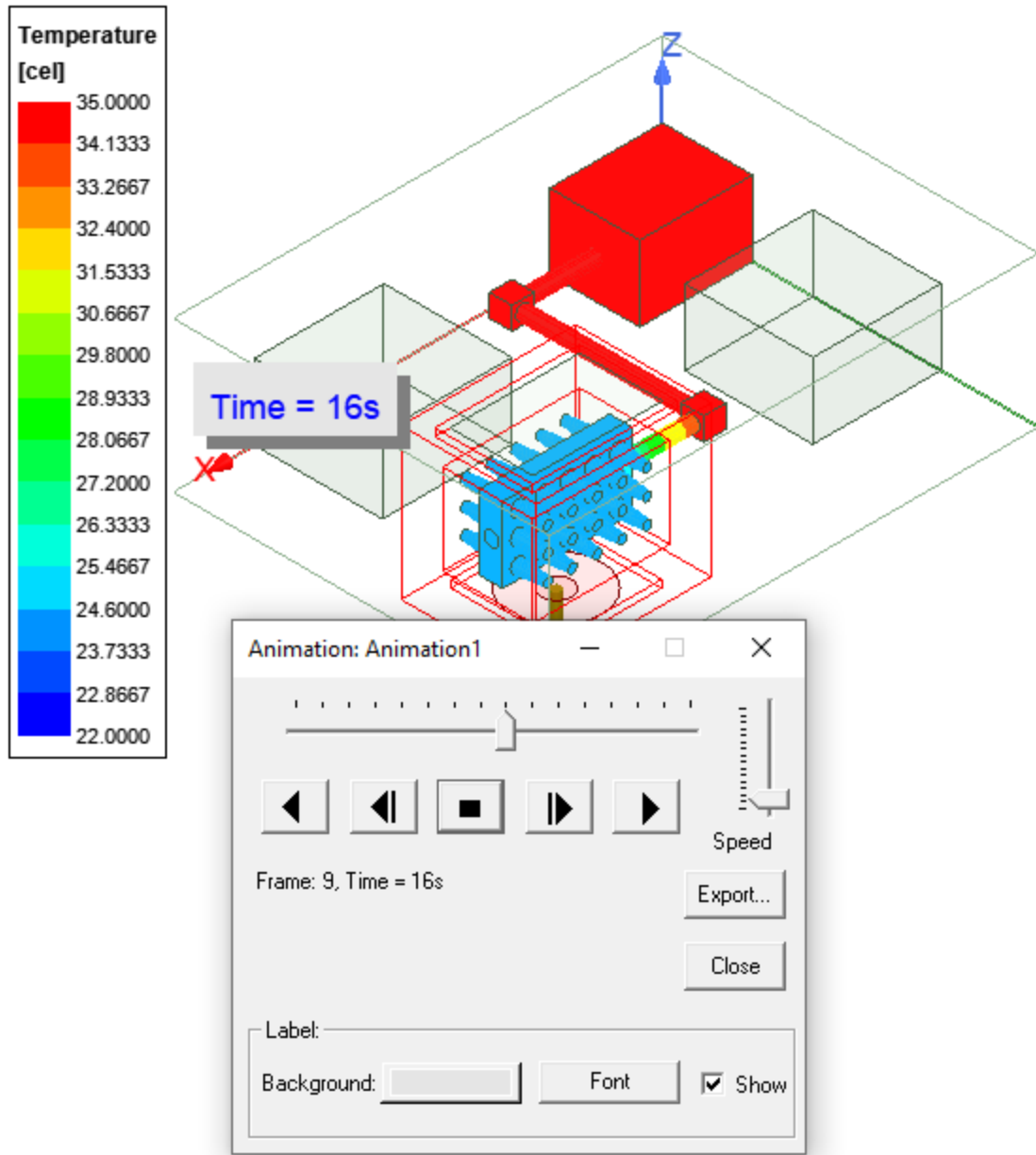

5. When finished viewing the animation, close the **Animation** dialog box.